

JVC

LCD Monitor

LT-42WX70EU



ENGLISH

HDMI[™]
HIGH-DEFINITION MULTIMEDIA INTERFACE

INSTRUCTIONS

Warning

Please follow all the guidelines below.

Never try to repair the product yourself!

- **To prevent electrical shock, do not open cover. Repair shall be done by service personnel only.**
- If the problem cannot be solved in “Troubleshooting” (→ page 38), unplug the power cord and contact your retailer.

If the product is damaged or behaving strangely, stop using it at once!

- Unplug the power cord and contact your retailer.

Follow this manual regarding setup!

- Connect only to a 100-240 V, 50 Hz/60 Hz AC outlet.

Make enough room for inserting and removing the power plug!

Place this product as close to the outlet as possible!

- Even if the product’s power lamp is unlit, the main power supply is not cut off unless the power cord is unplugged. The main power supply for this product is controlled by inserting or removing the power plug.

Do not use any power cord other than the provided with this product!

- Use of power cords other than provided may cause fire or malfunction.
- When several kinds of power cord are provided in the package, use the one which fits your AC outlet.

Connect the power cord to a grounding outlet.

- This plug will fit only into a grounded power outlet. If you are unable to insert the plug into the outlet, contact your electrician to install the proper outlet. Do not defeat the safety purpose of the grounded plug.
- When you insert the power cord to a grounding outlet, the product gets grounded.
- Improper grounding may lead to an electric shock.

Never cut or damage the power cord!

- If the power plug is not the right shape, or the power cord is not long enough, use an appropriate plug adapter or extension cable. (Consult your retailer.)

Do not allow the product to fall!

- Do not rest your elbows on, or allow children to hang from the product. There is a risk that the product will fall and cause injuries.
- Make use of the hole on the back of the stand to prevent the product from falling easily. (→ page vii)

When installing the monitor on the wall, ask your dealer to install.**When installing the product:**

- Use the cabinets or stands which are specified or recommended by the manufacturer.
- Use furniture on which the product can be installed steadily.
- Do not install the product in the way that any part of the product protrudes from the platform or furniture.
- Do not install the product on tall furniture (bookshelf, cupboard, etc.) without proper fixing.
- Do not install the product on a furniture-covering cloth or the like.
- Take care that children do not climb upon furniture to operate the product.

Take care when handling the glossy finish!

- For more details, see page vi.

Handle LCD panel with care!

- Use a soft, dry cloth when cleaning.

Hold the product so as not to scratch the screen!

- Do not touch the screen when carrying the product.

Never place anything on the product!

- Placing liquids, naked flames, cloths, paper, etc. on the product may cause a fire.

Never expose to rain or moisture!

- To prevent fire or electric shock, never allow liquids to enter the unit.

Never insert objects into the cabinet openings!

- It may cause a fatal electric shock. Take care when children are near.

Never obstruct the ventilation holes!

- It may cause overheating or a fire.

Do not carry the product on your own!

- In order to prevent accidents, ensure that the product is carried by two or more people.

On disposal of the product!

- Follow the instruction in “Information for Users on Disposal of Old Equipment and Batteries”. (→ page v)
- Registered trademarks, the model name, and power rating are written on the labels placed under the terminal cover on the rear of the product.
- For more details on installation, usage and safety, consult your retailer.

Note for United Kingdom power cord only

The plug of United Kingdom power cord has a built-in fuse. When replacing the fuse, be sure to use only a correctly rated approved type, re-fit the fuse cover. (Consult your dealer or qualified personnel.)

How to replace the fuse

Open the fuse compartment with the blade screwdriver, and replace the fuse.

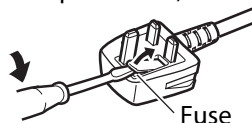

For UK only:

If you accidentally cut the power cord

Attach a new plug following the steps below. If in doubt, contact your local retailer.

Important

- Never connect to the larger terminal marked with an “E”, the safety earth symbol “⊥” or coloured green or green-and-yellow.
- The wires in the mains lead on this product are coloured with the following code:
 - Blue: Neutral wire (connect to the black terminal, or one marked “N”)
 - Brown: Live wire (connect to the red terminal, or one marked “L”)

Dear Customer,

This apparatus is in conformance with the valid European directives and standards regarding electromagnetic compatibility and electrical safety.

European representative of Victor Company of Japan, Limited is:

JVC Technical Services Europe GmbH

Postfach 10 05 04

61145 Friedberg

Germany

Information for Users on Disposal of Old Equipment and Batteries



Products

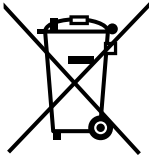

Battery

Notice:

The sign Pb below the symbol for batteries indicates that this battery contains lead.

[European Union]

These symbols indicate that the electrical and electronic equipment and the battery with this symbol should not be disposed of as general household waste at its end-of-life. Instead, the products should be handed over to the applicable collection points for the recycling of electrical and electronic equipment as well as batteries for proper treatment, recovery and recycling in accordance with your national legislation and the Directive 2002/96/EC and 2006/66/EC.

By disposing of these products correctly, you will help to conserve natural resources and will help to prevent potential negative effects on the environment and human health which could otherwise be caused by inappropriate waste handling of these products. For more information about collection points and recycling of these products, please contact your local municipal office, your household waste disposal service or the shop where you purchased the product. Penalties may be applicable for incorrect disposal of this waste, in accordance with national legislation.

[Business users]

If you wish to dispose of this product, please visit our web page <http://www.jvc.eu/> to obtain information about the take-back of the product.

[Other Countries outside the European Union]

These symbols are only valid in the European Union. If you wish to dispose of these items, please do so in accordance with applicable national legislation or other rules in your country for the treatment of old electrical and electronic equipment and batteries.

Maintenance

Cleaning the screen

The screen of this monitor is coated with layers of thin films, such as a coating to prevent unwanted reflections. Damages to these layers can lead to irreversible changes in appearance such as uneven colour, discolouration, and scratches. Follow the instructions below to prevent such troubles.

- Do not paste or stick anything using any glues or adhesive tapes.
- Do not write anything on the screen.
- Do not strike the screen with a hard object.
- Avoid condensation on the screen.
- Do not wipe the screen with solvent such as alcohol, thinner, or benzine.
- Do not wipe the screen forcefully.

If the screen gets stained, wipe it with a soft dry cloth or a soft cloth soaked in water or water-diluted neutral detergent and wrung well.

Cleaning the cabinet

Wipe stains off the cabinet with a soft cloth. If the cabinet gets heavily stained, wipe it with a soft cloth soaked in water-diluted neutral detergent and wrung well, then wipe with a soft dry cloth.

To avoid the deterioration or damages of the cabinet such as its paint's peeling away, be careful about the following:

- Do not wipe the cabinet using solvent such as alcohol, thinner, or benzine.
 - Do not expose the cabinet to any volatile substance such as insecticides.
 - Do not allow any rubber or plastic in contact for a long time.
-
- The top of the supplied stand is made of glass. Avoid physical shock and do not scratch it with hard objects.

Ventilation openings

Use a vacuum cleaner to get rid of the dust on and around the intakes (all the openings). If a vacuum cleaner is not available, use a cloth and wipe it off. Leaving the dust around the intakes may prevent proper temperature control and cause damage to the product.

Keep space around the product as illustrated below at minimum for proper ventilation.

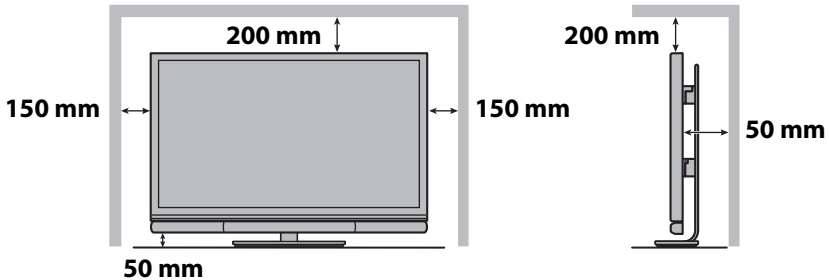

Warning

To prevent an accidental fall

When hanging on a wall

When attaching the monitor onto a wall, use the optional wall mounting unit.

Consult qualified installers for installation.

When fixing to furniture

- 1 Thread a belt (not supplied) through the hole on the back of the stand.
- 2 Fix the belt to the furniture using a screw.

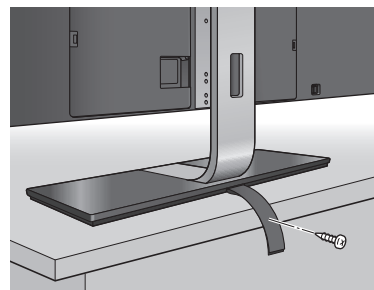
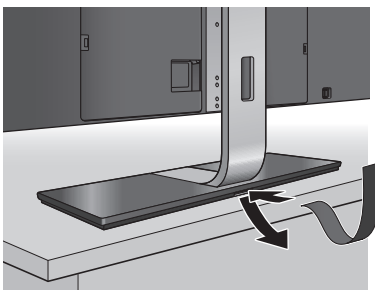

Features

- › Big screen suitable for SLR digital camera photographs → page A-11
- › Slim cabinet provides you with greater freedom of choice for installation
- › More precise adjustment of picture quality with a wide range of adjustment properties → page A-2
- › Quick response making video games more exciting — Game Mode → page A-5
- › Operating HDMI devices from the TV remote controller — HDMI CEC compatible → page 13



Contents

Warning	ii
Installation.....	04
Included items	04
Inserting batteries into the remote control	05
Attaching and connecting the speaker unit	05
Installation	05
To adjust the vertical position of monitor	06
Connecting external devices	08
Connecting the power cable/Turning on the power	10
Initial settings	10
Parts identification	11
Controlling HDMI devices	13
Changing the settings.....	14
Picture	15
Sound	27
Setup	29
HDMI	36
Troubleshooting	38
Specifications.....	41
Index	48

Technical information

Customize the picture to your taste.....	A-2
Set up the monitor for your PC	A-10
Enjoy SLR digital camera photographs	A-11
Menu index by task.....	A-12

You can search for picture/sound menu items from the adjustment you want to make, and quickly find the page containing detailed information.

Installation

Included items

- Main unit (monitor and stand)



- Speaker unit

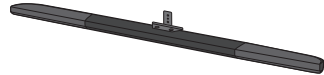

- Screws for the speaker unit



- Remote control unit



- AAA size batteries



- Video cable (D-sub 15 pin / RCA)

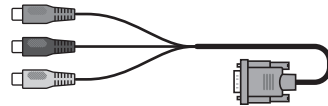

- Audio cable (3.5 mm stereo mini / RCA)



- Power cable

- Instructions (this book), startup sheet, other printed material

Inserting batteries into the remote control

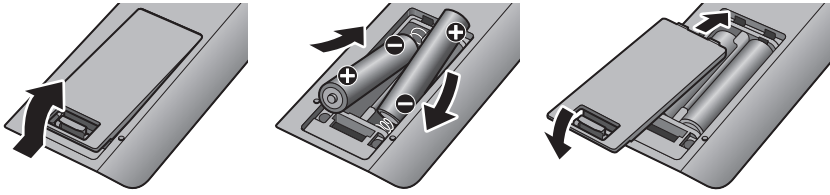

When replacing the batteries

To avoid short-circuit, place the minus end of the batteries first.

- Batteries shall not be exposed to excessive heat such as direct sunshine, fire or the like.
- Read the precautions on the battery.
- The batteries last about 6 to 12 months on regular usage.
- The included batteries are supplied for operation check and may last shorter.

Attaching and connecting the speaker unit

Attach the supplied speaker unit under the monitor using the supplied screws.

- Refer to the startup sheet for details.
- You can also connect speakers other than the supplied one. In this case, set "PEQ" to "Off". (→ page 28)

Impedance: 8 Ω or larger

Rated input power: 10 W or larger

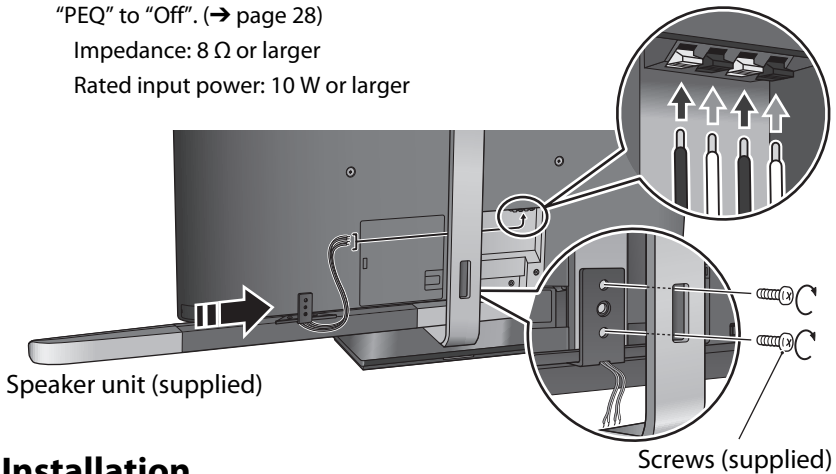

Installation

Install the unit properly referring to the cautions from pages ii to vii.

- Do not hold the speaker unit when carrying the monitor. Hold the stand base and the upper part of the monitor by two or more people.

To adjust the vertical position of monitor

The monitor is height-adjustable in 3 positions, by 5.5 cm at the maximum. Adjust the vertical position of the monitor when you need to place a device under the monitor.

1 Detach the monitor from the stand.

1-1 Spread a soft cloth on a flat table or floor to place the removed monitor on.

1-2 Remove the screw connecting the monitor and the stand.

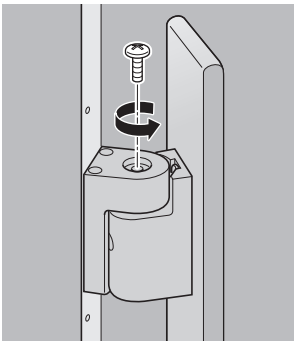

1-3 Detach the monitor from the stand.

- The monitor should be carried by two or more people.

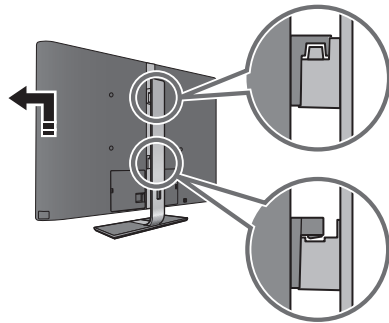

2 Change the position of the hooks.

2-1 Detach the two hooks from the monitor.

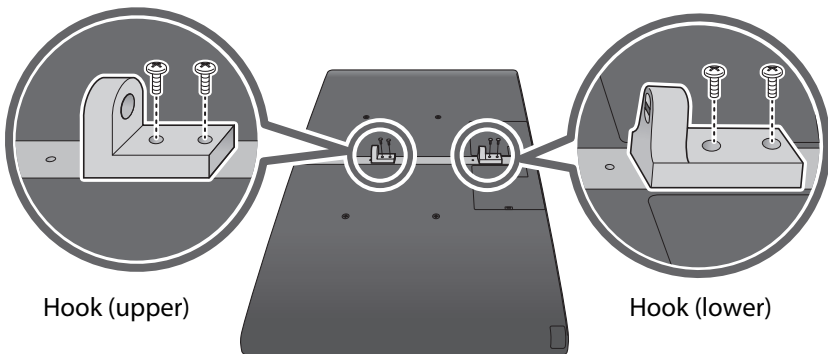

2-2 Attach the hooks again.

- Select the positions of the hooks according to the monitor position you want, and fix them with the screws.

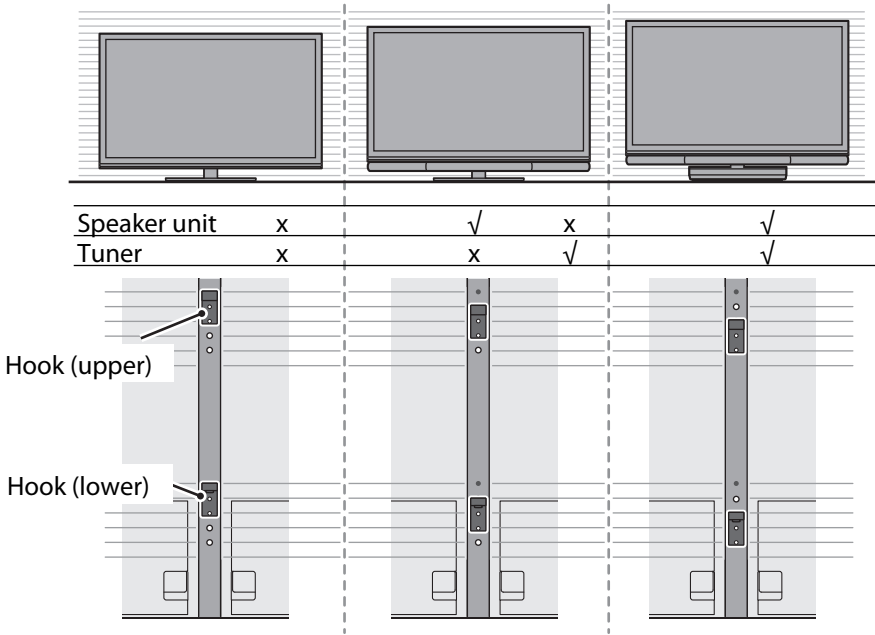

3 Attach the monitor to the stand.

3-1 Hang the monitor to the stand.

- After hanging the monitor on the stand, swing the monitor from side to side a few times so that the hooks on the monitor and the pivots on the stand engage properly in position.

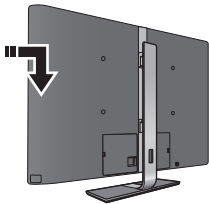

3-2 Fasten the screw.

- After fastening the screw, swing the monitor a few times to check if it is hinged with the stand properly. After that, fasten the screw tight again.

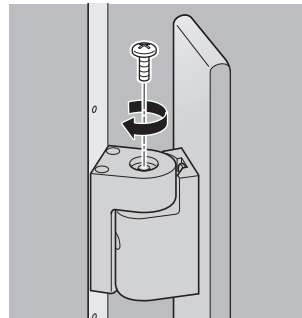

Connecting external devices

To connect an HDMI device

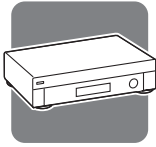

To INPUT-1/INPUT-2/
INPUT-3 terminals

To connect a device with component terminals

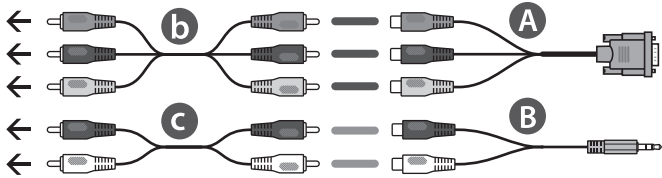
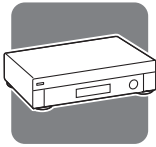

To connect a device with a composite terminal

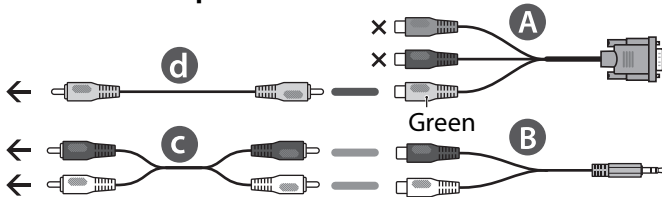
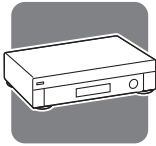

To connect a DVI device

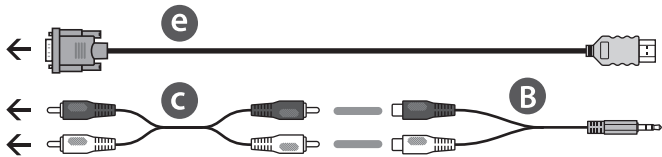
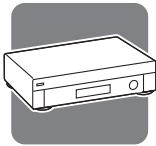

To connect a computer

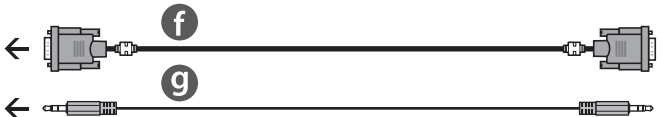

- HDMI™ (V.1.3, with Deep Color, with x.v.Colour™, HDMI™ CEC Support)

INPUT-2: HDMI™ terminal

INPUT-3: HDMI™ terminal

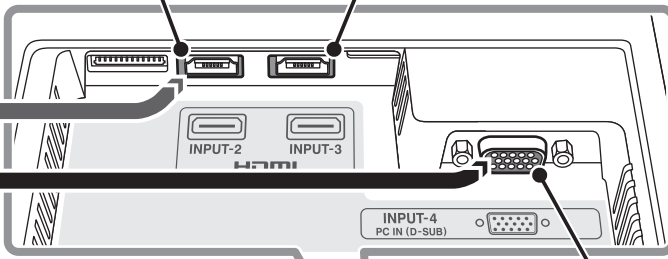

INPUT-1: HDMI™ terminal

INPUT-4 terminal:
D-sub 15 pin

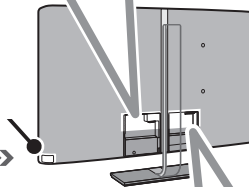

AUDIO INPUT terminal

Speaker terminals (→
page 05)

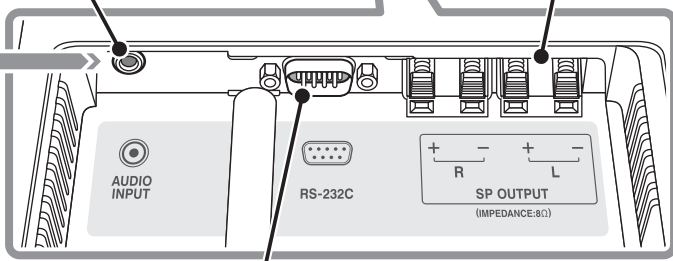

RS-232C terminal (For controlling the monitor from a computer.
Contact qualified personnel for detailed information.)

- | | |
|---|--|
| A: Video cable (supplied) | d: Video cable (separately purchased) |
| B: Audio cable (supplied) | e: DVI-HDMI cable (separately purchased) |
| a: HDMI cable (separately purchased) | f: VGA cable (separately purchased) |
| b: Component cable (separately purchased) | g: Audio cable (separately purchased) |
| c: Audio cable (separately purchased) | |

- When using the INPUT-4 terminal, set "Input-4 Setting" (→ page 33) properly according to the connected device.
- To reduce noise, use a VGA cable with core filters.
- When you connect a DVI device to INPUT-2 or INPUT-3, only the video signal is played back, and the sound signal is not.

Connecting the power cable/Turning on the power

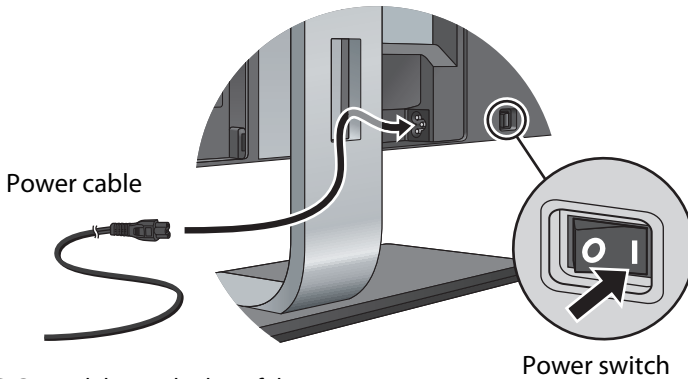

- Ground the earth plug of the power cable to the earth terminal of the AC outlet.
- When several kinds of power cord are provided in the package, use the one which fits your AC outlet.

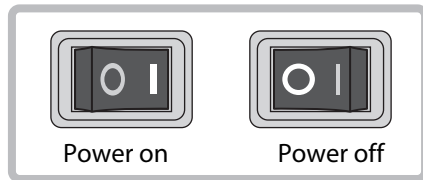

Initial settings

When you turn on the monitor for the first time, initial settings start. Select the menu language and the place of installation.

1 Select the menu language.

- 1-1 Select "Menu Language" and press the [OK] button.
- 1-2 Select from the list the language you want using the [▲▼] buttons, and press the [OK] button.
- 1-3 Select [Set] and press the [OK] button.

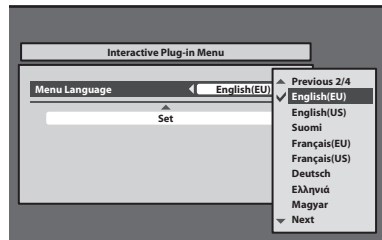

2 Select the place of installation.

- 2-1 Select "Place of Installation" and press the [OK] button.
- 2-2 Select the place of installation using the [▲▼] buttons, and press the [OK] button.
- 2-3 Select [Set] and press the [OK] button.

- In steps 1-1 and 2-1, you can also select a setting by pressing the [◀▶] buttons.

Parts identification

Main unit

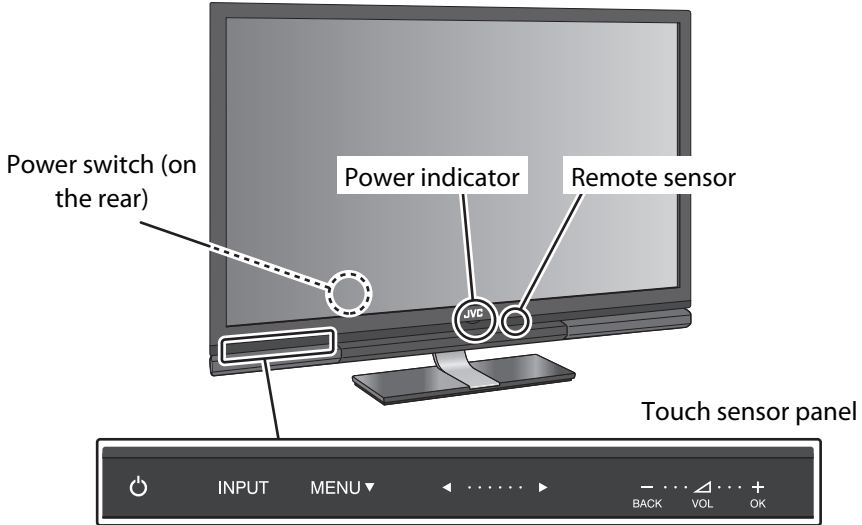

Power switch (on the rear) Turns on or off the main power supply.

Power indicator Lights while the monitor is on.

Remote sensor Aim the remote control here.

Touch sensor panel

Touch on the function name to operate the function. You hear a beep sound when the button is touched.

Power button Turns the monitor on/off (on standby).

INPUT Switches the input.





MENU ▾ Opens the setting menu. Functions as the down cursor key in the menu operations.

Left and right arrow keys Functions as the left cursor key and the right cursor key in the menu operations.

- BACK Turns down the volume. Functions as the BACK key in the menu operations.

+ OK Turns up the volume. Functions as the OK key in the menu operations.

Remote control

	Turns the monitor on/off (on standby).
LINK	Opens the operation window for HDMI CEC devices. (→ page 13)
OPTION	Opens the setup window of HDMI CEC devices.
MENU	Opens the setting menu. (→ page 14)
	Selects an item. (Cursor keys)
OK	Confirms your selection.
BACK	Goes back to the previous screen.
EXIT	Exits from the menu.
ZOOM	Changes the aspect. (→ page 30)
	Adjusts the volume.
	Attenuates the sound.
INPUT 1	
INPUT 2	Switches the input.
INPUT 3	
INPUT 4	

- Buttons not mentioned above are equipped for the operations of a TV tuner.



Controlling HDMI devices

You can control HDMI CEC devices connected to this monitor using the remote of the monitor.

- This function can be customized in the “HDMI” settings (→ page 36).
- Devices may not operate or may function differently from described, depending on the model or the manufacturer.

1 Press the [LINK] button.

Operation window appears.

2 Select the device to control.

Select the device name under “Device”.

3 Control the selected HDMI device.

- “Rec.” : Starts recording.
- “Rec.Stop” : Stops recording.
- “NAVIGATION” : Opens the playback menu of the HDMI device.
- “Function” : Opens the operation menu of the HDMI device.
- “Operation Panel” : Opens the operation panel.

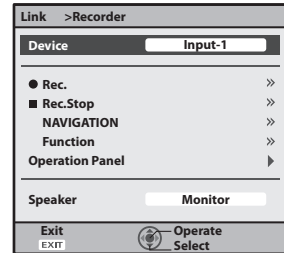

To select the audio output

When an HDMI CEC amplifier is connected to the monitor, you can select either the monitor or the amplifier as the device to output the sound signal.

- To output the sound from the amplifier, set “AMP Control” (→ page 37) to “On”, and connect the audio output terminals of the player into the amplifier.

1 Press the [LINK] button.

2 Select “Monitor” or “AMP” under “Speaker”.

- “Monitor” : The sound is output from the monitor. The volume buttons of the monitor control the volume of the monitor.
- “AMP” : The sound is output from the amplifier. The volume buttons of the monitor control the volume of the amplifier.

Changing the settings

Example: to change the setting of “Colour Temperature”

1 Open the menu.



2 Select “Picture”.

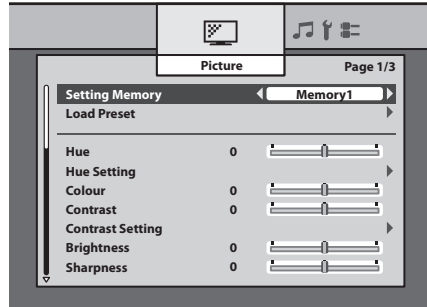
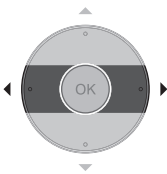

3 Select “Colour Temperature”.

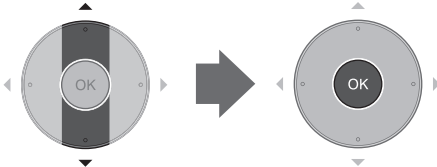

● The item currently selected is shown in orange.

4 Select the setting you want.

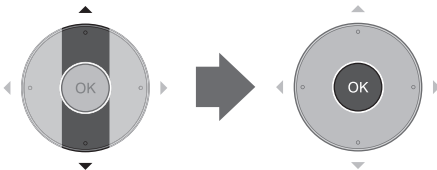

● When the selected item is followed by an adjustment screen, press the [◀▶] buttons to make adjustments.

5 Finish the setting.



Picture		→ page 15
Sound		→ page 27
Setup		→ page 29
HDMI		→ page 36

Technical information

Customize the picture to your taste	A-2
Set up the monitor for your PC	A-10
Enjoy SLR digital camera photographs	A-11
Menu index by task	A-12

Show Your True Colours.



Customize the picture to your taste

To use a preset

1 Open the menu.

2 Select a memory from “Setting Memory” in “Picture”.

In the initial setting, 6 presets are assigned to each memory as follows:

- Memory1 : Standard
 - Memory2 : Dynamic
 - Memory3 : Theater
 - Memory4 : Monitor
 - Memory5 : Photo Pro
 - Memory6 : Game
-
- See page A-4 for the detail of each preset.
 - If you have modified the settings (→ next page), the settings of each memory are different from the default.
 - When the input is changed, the memory used for the input last time is automatically applied.

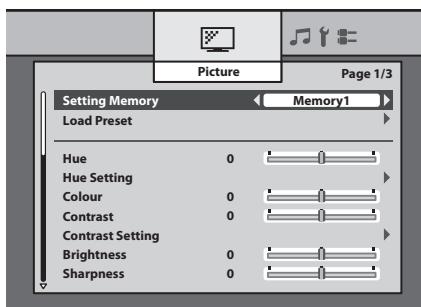

This monitor features rich menus for picture control, in addition to 6 pre-installed sets of picture settings carefully prepared by JVC to suit various types of video content and viewing environment.

Enjoy controlling appearance of pictures using the "Picture" menu, and create your own picture settings.

Customizing the settings

You can create your own set of picture settings by arranging the settings of a preset. Storing several sets of settings helps you to enjoy a picture in the taste you like according to the viewing environment and characteristics of the source.

- 1 Open the menu.**
- 2 Select the memory you want to adjust from "Setting Memory" in "Picture".**
- 3 Adjust items in "Picture".**
 - See pages 16 and later for the detail of menu items.
 - Adjustments are stored into the selected memory as you change the settings.
 - To make another set of picture settings, select another memory in step 2 above and start adjustments.

To reset the settings

If you do not like your current adjustments, load either of the preset settings into the memory which you want to reset. Settings of the selected memory are overwritten by those of the loaded preset setting.

- 1 Open the menu.**
- 2 Select the memory you want to reset from "Setting Memory" in "Picture".**
- 3 Select "Load Preset", select one of the preset settings, and press "Load".**

● Characteristics of the 6 presets

Standard

Suitable for watching TV programs and DVDs in a living room.



Dynamic

Makes pictures colourful and bright, suitable for watching in a well-lighted room.



Theater

Suitable for watching cinemas in a dark room.





Monitor

Does not apply colour adjustments or noise reductions. Input video signals are displayed as they are. Suitable for monitoring purpose.



Photo Pro

Suitable for watching still pictures of SLR digital cameras.



Game

Gives priority to the response time for picture movement. Suitable for game consoles.

→ See the following pages for the setting values of each preset.

● Setting values of each preset

- The settings are subject to change for amelioration.

	Standard	Dynamic	
Hue	0	0	
Hue Setting			
BY Gain	2	2	
BY/RV Angle	2	0	
Colour	0	5	
Contrast	0	4	
Contrast Setting			
Black Stretch	Medium	High	
Dynamic DC Offset	On	On	
Auto Contrast	Off	On	
Brightness	0	0	
Sharpness	0	10	
Enhancer	Mode-3	Mode-3	
Enhancer Setting			
Detail	-5	0	
H.Sharp	10	15	
V.Sharp	10	15	
Backlight	10	30	
Backlight Setting			
Smart Picture	On	Off	
Dynamic Backlight	Medium	High	
Colour System	Auto	Auto	
Colour Matrix	Auto	Auto	
Colour Space	Auto	Auto	
Colour Temperature	Normal	Cool2	

	Theater	Monitor	Photo Pro	Game
	0	0	0	0
	0	0	0	0
	2	0	0	0
	0	0	0	0
	0	0	0	0
	Low	Off	Off	Off
	On	Off	Off	Off
	Off	Off	Off	Off
	0	0	0	0
	0	-30	0	-15
	Mode-4	Mode-5	Mode-5	Mode-5
	0	0	-15	0
	5	0	-5	0
	0	0	0	0
	0	0	10	10
	On	Off	Off	On
	Low	Off	Off	Off
	Auto	Auto	Auto	Auto
	Auto	Auto	Auto	Auto
	Normal	Normal	sRGB	Auto
	Warm2	Warm2	Warm2	Cool2

	Standard	Dynamic	
White Balance Setting			
R Drive / G Drive / B Drive	0	0	
R Cutoff / G Cutoff / B Cutoff	0	0	
Colour Management	Mode-2	Mode-1	
Colour Mngmt. Setting			
Red Hue / Red Colour	0	0	
Yellow Hue / Yellow Colour	0	0	
Green Hue / Green Colour	0	0	
Cyan Hue / Cyan Colour	0	0	
Skin Hue / Skin Colour	0	0	
Colour : Bright Area	0	0	
Colour : Dark Area	0	0	
Gamma	Mode-2	Mode-1	
Picture Management	Medium	High	
Noise Reduction			
Digital VNR	Auto	Auto	
MPEG NR	Low	Low	
3DY/C	On	On	
Natural Cinema	Auto	Auto	
Picture Delay Time	Normal	Normal	
PC Monitor Mode	Off	Off	
Eco Mode	Off	Off	
Other			
Real Bit Driver	On	On	
100/120Hz CMD	On	On	

	Theater	Monitor	Photo Pro	Game
	0	0	0	0
	0	0	0	0
	Mode-3	Off	Off	Mode-2
	0	0	0	0
	0	0	0	0
	0	0	0	0
	0	0	0	0
	0	0	0	0
	0	0	0	0
	0	0	0	0
	Mode-4	Mode-4	Mode-4	Mode-3
	Low	Off	Off	Medium
	Auto	Off	Auto	Auto
	Low	Off	Off	Low
	On	Off	On	On
	Auto	Off	Off	Off
	Normal	Normal	Normal	Middle
	Off	Off	Off	Off
	Off	Off	Off	Off
	On	On	On	On
	On	On	Off	On

Set up the monitor for your PC

Selecting the input signal

When you connect a PC to the INPUT-4 terminal, set the type of the input signal accordingly.

- **For signals in VGA60 and XGA60**

Set "Sampling Mode" to "Std". (→ page 34)

- **For signals in WVGA60**

Set "Sampling Mode" to "Wide". (→ page 34)

- **For signals in WXGA (1280), WXGA (1360) and WXGA60**

1 Set "Sampling Mode" to "Wide". (→ page 34)

2 Set "WXGA Select" as follows. (→ page 34)

- For signals in WXGA (1280): "1280*768"
- For signals in WXGA (1360): "1360*768"
- For signals in WXGA60: "1366*768"

- **For signals in SXGA60**

Set "SXGA / SXGA+" to "SXGA". (→ page 34)

- **For signals in SXGA+60**

Set "SXGA / SXGA+" to "SXGA+". (→ page 34)

If the picture is not aligned vertically, or letters on the screen look blurred

Set the aspect to "1:1", and adjust "Dot Clock" and "Clock Phase". (→ page 35)

- For signals in 1920 x 1080, set the aspect to "Full" and adjust the same items.

If the picture is cropped, or extra margins are displayed around it

- 1 Set the aspect to "Full".**
- 2 Adjust the position of the picture using "PC Position Adjustment" until the upper left corner of the picture is positioned at the upper left corner of the display.**
- 3 Adjust the size of the picture using "H Size" and "V Size" until the bottom right corner of the picture is positioned at the bottom right corner of the display.**

Enjoy SLR digital camera photographs

When you select the picture preset of "Photo Pro" in "Setting Memory", you can view the photographs just the way they were taken.

For JPEG pictures, select "sRGB" or "AdobeRGB" under the setting of "Colour Space" (→ page 20) according to the setting of your camera, so that the photographs are displayed more faithfully to the original.

- In the factory default, "Photo Pro" is installed in "Memory5" of "Setting Memory". (→ page A-2)
- It is recommended not to modify the settings of "Photo Pro". In the initial setting of "Photo Pro", "Colour Space" is set to "sRGB".

Menu index by task

Page

Hue adjustment	General tone of colour	Hue	16
	Tone of colour (including white)	Colour Temperature	21
	Tone of colour (in detail)	White Balance Setting	21
	Range of colour representation	Colour Space	20
	Amplitude of the colour difference signal	Hue Setting > BY Gain	16
	Demodulation angle of the colour difference signal	Hue Setting > BY/RV Angle	16
	Pattern of colour correction	Colour Management	22
	Colour correction (in detail)	Colour Mngmt. Setting > Red Hue, Yellow Hue, etc.	22
Colour adjustment	Total density of colour	Colour	16
	Amplitude of the colour difference signal	Hue Setting > BY Gain	16
	Demodulation angle of the colour difference signal	Hue Setting > BY/RV Angle	16
	Pattern of colour correction	Colour Management	22
	Colour correction (in detail)	Colour Mngmt. Setting > Red Colour, Yellow Colour, etc.	22
Brightness (backlight)	Total brightness of pictures	Backlight	18
	Reduces backlight in bright scenes	Backlight Setting > Smart Picture	19
	Reduces backlight in dark scenes	Backlight Setting > Dynamic Backlight	19
	Adjusts backlight depending on the luminance of the room	Eco Mode	26
Brightness (signal)	Total brightness of pictures	Brightness	17
	Adjusts the gain of the signal level	Contrast	17
	Emphasizes darker areas automatically	Contrast Setting > Black Stretch	17
	Reduces brightness in bright scenes	Contrast Setting > Dynamic DC Offset	17
	Emphasizes bright areas automatically	Contrast Setting > Auto Contrast	17
	Gamma correction value	Gamma	23
	Adjusts gamma value automatically	Picture Management	23
Sharpness	Sharpness	Sharpness	18
	Sharpness (in detail)	Enhancer Setting	18
	Frequency band to enhance	Enhancer	18
Sound	Bass sound	Bass	27
	Treble sound	Treble	27
	Equalizer suited for the speakers	PEQ	28
	Adjusts the delay time of sound	Lip Sync	27

Picture

Setting Memory

You can store up to 6 sets of the "Picture" settings and use them.

- When the input is changed, the memory used for the input last time is automatically applied.
- **Memory1 / Memory2 / Memory3 / Memory4 / Memory5 / Memory6**

Load Preset

You can load one of the presets below into a memory.

You can do further adjustment based on the loaded settings.

- Select a preset and press "Load" to load a preset.
- **Dynamic** : Makes pictures colorful and bright, suitable for watching in a well-lighted room.
- **Standard** : Suitable for watching TV programs and DVDs in a living room.
- **Theater** : Suitable for watching cinemas in a dark room.
- **Monitor** : Applies no colour corrections or noise reductions. Input video signals are displayed as they are.
- **Photo Pro** : Suitable for watching still pictures.
- **Game** : Gives priority to the response time for picture movement. Suitable for playing video games.



Hue

Adjusts the tone of colour.

- **-30 – +30** (Skin colour reddish ↔ Skin colour greenish)

Hue Setting

Adjusts the tone of colour in detail.

- The setting is fixed to 0 and unadjustable when “Colour Space” is set to “sRGB”, “AdobeRGB”, or “x.v.Colour”.
- The setting is fixed to 0 and unadjustable when “Colour Space” is set to “Auto” and the xvYCC signal is input to the HDMI terminal.
- The setting is fixed to 0 and unadjustable when “PC Monitor Mode” is set to “On”.

◆ **BY Gain**

Adjusts the amplitude of the B-Y colour difference signal. You can modify the total colouring of the picture.

- **-30 – +30** (Small amplitude ↔ Large amplitude)

◆ **BY/R Y Angle**

Adjusts the demodulation angle between the B-Y colour difference signal and the R-Y colour difference signal. You can modify the total colouring of the picture.

- **-15 – +15** (Decreasing the angle ↔ Increasing the angle)

Colour

Adjusts the density of colour.

- **-30 – +30** (Dilute ↔ Dense)

Contrast

Adjusts the brightness of brighter areas of pictures.

- **-30 – +30** (Dark ↔ Bright)

Contrast Setting

Adjusts settings of functions relating with contrast.

- The functions are not available when “Colour Space” is set to “sRGB” or “AdobeRGB”.
 - The functions are not available when “PC Monitor Mode” is set to “On”.
- ◆ **Black Stretch**
Emphasizes darker areas depending on the characteristics of a picture to make contrast clearer.
 - **High / Medium / Low / Off**
 - ◆ **Dynamic DC Offset**
Controls the blackness of the picture automatically depending on the total brightness.
 - **On / Off**
 - ◆ **Auto Contrast**
Emphasizes brighter areas depending on the characteristics of a picture to make contrast clearer.
 - **On / Off**

Brightness

Adjusts blackness.

- **-30 – +30** (Dark ↔ Bright)



Sharpness

Emphasizes outlines on a picture.

- The setting is unadjustable when “Enhancer” is set to “Off”.
- **-30 – +30** (Fuzzy ↔ Sharp)

Enhancer

Selects the frequency band enhanced by “Sharpness”.

- **Off** : Deactivates the function.
- **Mode-1 / Mode-2 / Mode-3 / Mode-4 / Mode-5**
(Emphasizes lower frequency band; for low-resolution picture ↔
Emphasizes higher frequency band; for high-resolution picture)

Enhancer Setting

Adjusts the effects of “Enhancer” in detail.

- All the settings are unadjustable when “Enhancer” is set to “Off”.

◆ Detail

Adjusts texture of surface.

- **-15 – +15** (Weaker ↔ Stronger)

◆ H.Sharp

Adjusts sharpness of horizontal outlines.

- **-15 – +15** (Weaker ↔ Stronger)

◆ V.Sharp

Adjusts sharpness of vertical outlines.

- **-15 – +15** (Weaker ↔ Stronger)

Backlight

Adjusts the brightness of backlight.

- **-30 – +30** (Darker ↔ Brighter)

Backlight Setting

Adjusts settings of functions relating with backlight.

◆ Smart Picture

Reduces the backlight automatically in dazzling scenes.

- **On / Off**

◆ Dynamic Backlight

Reduces the backlight automatically in dark scenes to represent black deeper.

- **High / Medium / Low / Off**

Colour System

Selects the colour system for the picture signal which is input to INPUT-4 from composite terminal.

- The setting is adjustable only when "Input-4 Setting" is set to "Composite".
(→ page 33)
- The setting is unadjustable when "PC Monitor Mode" is set to "On".
- **Auto** : An appropriate colour system is automatically applied depending on the type of the input signal. Normally select this.
- **PAL/50** : When the colour system is PAL.
- **PAL/60** : When the colour system is PAL 60.
- **SECAM** : When the colour system is SECAM.
- **NTSC3.58** : When the colour system is NTSC 3.58.
- **NTSC4.43** : When the colour system is NTSC 4.43.
- **PAL M** : When the colour system is PAL-M.
- **PAL N** : When the colour system is PAL-N.



Colour Matrix

Selects the colour matrix used for colour conversion.

- The setting is fixed to "Auto" and unadjustable when "Colour Space" is set to "sRGB", "AdobeRGB", or "x.v.Colour".
- The setting is fixed to "Auto" and unadjustable when "PC Monitor Mode" is set to "On".
- The setting is fixed to "Auto" and unadjustable when "Colour Space" is set to "Auto" and the xvYCC signal is input to the HDMI terminal.
- **Auto** : An appropriate colour matrix is applied automatically.
- **709** : The colour matrix conforming ITU-R BT.709 is used for conversion.
- **601** : The colour matrix conforming ITU-R BT.601 is used for conversion.

Colour Space

Changes the range of colour representation.

- "sRGB" or "AdobeRGB" is selectable when "PC Monitor Mode" is set to "On".
- Even when "Auto" is selected, the setting may not switch to "x.v.Colour" automatically depending on the connected device or the connection status.
- **Auto** : Normally applies "Wide". When the xvYCC signal is input to the HDMI terminal, "x.v.Colour" is applied automatically.
- **Normal** : HDTV standard.
- **Wide** : The wide colour gamut of the equipped LED panel. (Wider than the HDTV standard.)
- **x.v.Colour** : Colour representation suitable for x.v.Colour.
- **sRGB** : Colour representation suitable for sRGB.
- **AdobeRGB** : Colour representation suitable for AdobeRGB.

Colour Temperature

Adjusts colour temperature (colour tone). A picture becomes more bluish as colour temperature becomes higher.

- The setting is fixed to "Warm2" and unadjustable when "Colour Space" is set to "sRGB" or "AdobeRGB".
 - The setting is fixed to "Warm2" and unadjustable when "PC Monitor Mode" is set to "On".
- **Cool1 / Cool2 / Normal / Warm1 / Warm2**
(Higher temperature ↔ Lower temperature)

White Balance Setting

Adjusts colour temperature in detail; subtle control of RGB gradations.

- These settings are independent of the setting of "Colour Temperature".
- ◆ **R Drive / G Drive / B Drive**
Adjusts the depth of R/G/B on bright areas.
■ **-30 - +30** (Dilute ↔ Dense)
- ◆ **R Cutoff / G Cutoff / B Cutoff**
Adjusts the depth of R/G/B on dark areas.
■ **-30 - +30** (Dilute ↔ Dense)



Colour Management

Adjusts the total colouring of pictures. Three colour management presets are available to suit a variety of colour temperature settings.

- The setting is fixed to "Off" and unadjustable when "Colour Space" is set to "sRGB", "AdobeRGB", or "x.v.Colour".
- The setting is fixed to "Off" and unadjustable when "PC Monitor Mode" is set to "On".
- The setting is fixed to "Off" and unadjustable when "Colour Space" is set to "Auto" and the xvYCC signal is input to the HDMI terminal.
- **Mode-1** : Improving the vividness of colours. Suitable for high colour temperature.
- **Mode-2** : Standard colours. Suitable for normal colour temperature.
- **Mode-3** : Improving the total toning of colours. Suitable for low colour temperature.
- **Off** : Deactivates the function.

Colour Mngmt. Setting

Adjusts the total colouring of pictures in detail.

- All the settings are fixed to 0 and unadjustable when "Colour Management" is set to "Off".
 - All the settings are fixed to 0 and unadjustable when "Colour Space" is set to "sRGB", "AdobeRGB", or "x.v.Colour".
 - All the settings are fixed to 0 and unadjustable when "PC Monitor Mode" is set to "On".
 - All the settings are fixed to 0 and unadjustable when "Colour Space" is set to "Auto" and the xvYCC signal is input to the HDMI terminal.
- ◆ **Red Hue / Red Colour**
Adjusts the tone/colourfulness of red colours.
■ **-15 - +15** (Magenta ↔ Yellow) / **-30 - +30** (Dilute ↔ Dense)
- ◆ **Yellow Hue / Yellow Colour**
Adjusts the tone/colourfulness of yellow colours.
■ **-15 - +15** (Red ↔ Green) / **-30 - +30** (Dilute ↔ Dense)



◆ **Green Hue / Green Colour**

Adjusts the tone/colourfulness of green colours.

■ **-15 - +15** (Yellow ↔ Cyan) / **-30 - +30** (Dilute ↔ Dense)

◆ **Cyan Hue / Cyan Colour**

Adjusts the tone/colourfulness of blue colours.

■ **-15 - +15** (Green ↔ Blue) / **-30 - +30** (Dilute ↔ Dense)

◆ **Skin Hue / Skin Colour**

Adjusts the tone/colourfulness of skin colours.

■ **-15 - +15** (Red ↔ Yellow) / **-30 - +30** (Dilute ↔ Dense)

◆ **Colour : Bright Area**

Adjusts the colour depth of bright areas.

■ **-15 - +15** (Dilute ↔ Dense)

◆ **Colour : Dark Area**

Adjusts the colour depth of dark areas.

■ **-15 - +15** (Dilute ↔ Dense)

Gamma

Adjusts the gamma correction value and controls the brightness and gradation of intermediately bright areas.

■ **Mode-1 / Mode-2 / Mode-3 / Mode-4 ($\gamma = 2.2$) / Mode-5 / Mode-6**
(Brighter ↔ Darker)

Picture Management

Adjusts gamma value automatically depending on the brightness of pictures.

■ **High / Medium / Low / Off**

Noise Reduction

Adjusts the settings of picture noise reduction.

- The functions are unavailable when "PC Monitor Mode" is set to "On" or when signals in a PC signal format are coming in.

◆ Digital VNR

Reduces picture noise.

- **Auto** : Estimates the amount of noise automatically and applies suitable noise reduction processing.
- **High / Medium / Low / Off**

◆ MPEG NR

Reduces noise on MPEG pictures such as mosquito-noise and block-noise.

- **High / Low / Off**

3DY/C

Detects the type of the picture signal (movie or still picture) which is input to INPUT-4 from composite terminal and applies a suitable Y/C separation process to each type.

- Unavailable when "Picture Delay Time" is set to "Short".
- Unavailable when the format of the incoming signal is other than NTSC 3.58, PAL50, PAL M or PAL N.
- **On / Off**

Natural Cinema

Displays quick-moving parts on cinemas originally taken on films with more clarity.

- The setting is fixed to "Off" and unadjustable when "Picture Delay Time" is set to "Short".
- The setting is fixed to "Off" and unadjustable when "PC Monitor Mode" is set to "On".
- The setting is fixed to "Off" and unadjustable when progressive picture signal is input.

■ **Auto / Off**

Picture Delay Time

Adjusts the time spent for picture-improving processes. The delay time becomes shorter though picture quality is down when the processes are skipped.

- The setting is fixed to "Short" and unadjustable when "PC Monitor Mode" is set to "On".

■ **Normal** : The picture-improving processes are fully applied, giving priority to picture quality.

■ **Middle** : Some picture-improving processes are skipped to decrease the delay time.

■ **Short** : Most of picture-improving processes are skipped to decrease the delay time more.

PC Monitor Mode

Sets the monitor for use as a PC monitor.

- Only menu items which are necessary for PC monitors are activated.
- Input signals from HDMI terminals are recognized as PC signals (R:G:B = 4:4:4) and are processed appropriately.

■ **On / Off**



Eco Mode

Adjusts the brightness of backlight depending on the luminance of the room to reduce power consumption.

- **Demo** : Activating the function and indicating its performance.
- **On** : Activating the function. Its performance is not indicated.
- **Off** : Deactivates the function.

Other

◆ Real Bit Driver

Makes the gradation of 8 bit signals natural and smooth.

- Also effective on signals not in 8 bit.

■ **On / Off**

◆ 100/120Hz CMD

Doubles the number of frames per second to reduce image blur.

- The setting is fixed to "Off" and unadjustable when "Colour Space" is set to "sRGB" or "AdobeRGB".
- The setting is fixed to "Off" and unadjustable when "Picture Delay Time" is set to "Short".
- The setting is fixed to "Off" and unadjustable when "PC Monitor Mode" is set to "On".

■ **On / Off**

Sound

Bass

Adjusts bass tone.

- **-6 – +6** (Weaker ↔ Stronger)

Treble

Adjusts treble tone.

- **-6 – +6** (Weaker ↔ Stronger)

Balance

Adjusts sound balance.

- **L10 – 10R** (To the left ↔ To the right)

Auto Volume Control

Turns down the volume automatically when an excessive strong sound signal is input.

- **On / Off**

Lip Sync

Adjusts the delay time of sound.

- **-3 – +3** (The sound starts earlier ↔ The sound starts later)



PEQ

Optimizes the sound for the monitor's supplied speaker unit. Select "Off" when connecting other speakers.

- **On / Off**

Turn On Volume

Adjusts the initial volume when turning on the monitor.

- **0 – 50**
- **Current** : Setting the current volume to the initial.
 - If the setting value surpasses that of "Volume Limit", the initial volume at turning on becomes the maximum value set for "Volume Limit".
 - Amplifiers connected to an HDMI terminal ignore this setting.

Volume Limit

Sets the maximum volume to prevent unexpectedly loud sound reproduction.

- **0 – 50**
- Amplifiers connected to an HDMI terminal ignore this setting.

Reset

Restores the settings of "Sound" to the initial.

Setup

Menu Language

You can choose the language used for on-screen messages.

- **English (EU) / Deutsch / Français(UE) / Italiano / Español (UE) / Català / Nederlands / Dansk / Svenska / Norsk / Suomi / Polski / Magyar / Русский / Ελληνικά / Português / Český / Български / Українська / Türkçe / Română / العربية / 繁體中文 / 中文 / فارسی / Bahasa Melayu / ไทย / Español (US) / Français(US) / English (US) / 日本語**

Front Panel Lock

Makes operations through the buttons on the monitor ineffective.

- **On** : Making the buttons on the monitor ineffective.
- **Off** : Making the buttons on the monitor effective.
 - You can turn on/off the power by pressing and holding the [⏻] button on the monitor for more than 3 seconds even when the setting is "On".
 - You can change the setting to "Off" by pressing and holding the [MENU] button on the monitor for more than 3 seconds.
 - The settings returns to "Off" after disconnecting the power cord.

Auto Shut Off

Turns off the monitor automatically when no signal comes in.

- **On** : Turns off the monitor automatically when no signal comes in and no operation is done for 10 minutes.
- **Off** : Deactivates the function.



Zoom

Adjusts the aspect of pictures.

- The setting is also adjustable through the [ZOOM] button on the remote control.

◆ Options when the current input signal is SD

- **Auto** : When the video signal contains information about aspect ratio (WSS etc.), the aspect is switched accordingly. In other cases, the picture is displayed in either "Regular" or "Panoramic", depending on the setting of "4:3 Aspect Setting" (→ page 33).

- **Regular** : No modifying of aspect. Black areas remain at the left and right side of the picture.

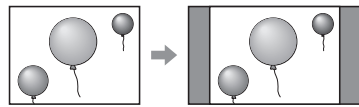

- **Panoramic** : Zooming a picture to the width of the monitor without unnatural deformation.

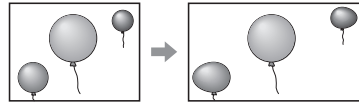

- **14:9 Zoom** : Zooming a 14:9-aspect picture in the way that the upper and lower black bands are edged out. Black areas remain at the left and right side of the picture.

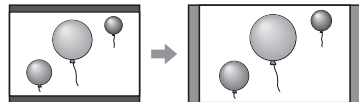

- You cannot select "14:9 Zoom" for signals in 480i and 480p.

- **16:9 Zoom** : Zooming a picture in the way that the upper and lower black bands in a cinema program are edged out.

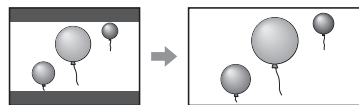

- **16:9 Zoom Subtitle** : Zooming a picture in the way that the upper and lower black bands of a cinema program are edged out leaving space for captions.

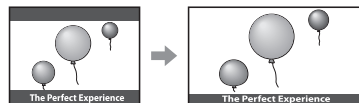

- **Full** : Stretching a picture to the width of the monitor.

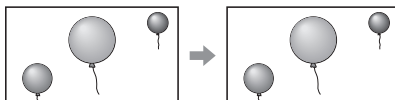

◆ Options when the current input signal is HD

● You can select "Full Native" only when the input signal is 1080i/p.

■ **Full** : Stretching a picture to the width of the monitor.

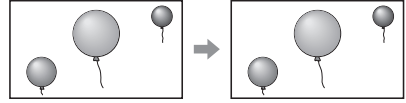

■ **Full Native** : Displaying a picture of 1080i/p without enlargement.

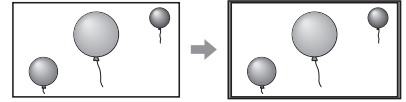

■ **Slim** : Shrinking a picture horizontally. Black areas remain at the left and right side of the picture.

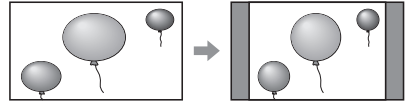

■ **Panoramic Zoom** : Zooming a picture without unnatural deformation in the way to edge out the black parts around a 4:3-aspect cinema program transferred through 16:9-aspect signal.

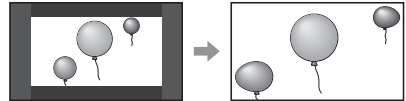

◆ Options when the current input signal is from a PC

● You cannot select "Just" and "1:1" for some input signals.

■ **Full** : Stretching a picture to the width of the monitor.

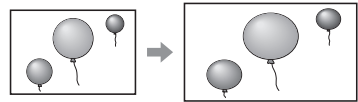

■ **Just** : No modifying of aspect. Black areas remain at the left and right side of the picture.

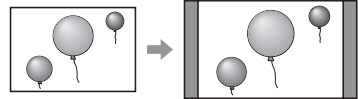

■ **1:1** : No modifying of aspect or resolution. Black areas remain around the picture.

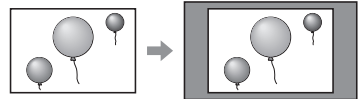

Position Adjustment

Adjusts the picture position on the monitor.

- Vertical adjustment is effective when "Zoom" is set to "14:9 Zoom", "16:9 Zoom", "Panoramic", "16:9 Zoom Subtitle", or "Panoramic Zoom".
- Horizontal adjustment is effective only when "Zoom" is set to "Panoramic Zoom".
- When a PC signal is input, adjust the position on "PC Position Adjustment" in "PC Setting".
- The positioning is reset as the power is turned off.
- The positioning is reset as the signal format changes.
- The positioning is reset as the signal aspect changes.

Power Indicator

Sets the action of the power indicator.

- **On** : The power indicator remains lit while the power is on.
- **Off** : The power indicator does not light.
- The power indicator lights regardless of this setting if no signal is input while the power is on.

Information

Displays the source indication.

- **On / Off**
- The source indication appears regardless of this setting if no signal is input.
- The source indication is displayed for 4 seconds after changing the source even if the setting is "Off".

Input Label

Adds a source name specifying a device after the source name ("Input-1" - "Input-4").

- **(No label) / VCR / DVD / Blu-ray Disc / PVR / D-VHS / STB / SAT / AMP / GAME / CAM / DISC / PC**

4:3 Aspect Setting

Selects the aspect setting which is applied when "Zoom" (→ page 30) is set to "Auto". The picture is displayed in the selected aspect when the aspect is 4:3 or when the monitor cannot detect the aspect of a picture.

- **Regular** : Displays the picture in "Regular".
- **Panoramic** : Displays the picture in "Panoramic".

1080 Auto Setting

Selects the default aspect for 1080i/p signals.

- **Full** : Expands the picture to the full display size.
- **Full Native** : Displays the picture in the same magnification (100% scan).

Input-4 Setting

Selects the signal type for the INPUT-4 terminal (D-sub 15 pin).

- Use the supplied conversion cables and other cords according to the type of connection. (→ page 08)
- **PC** : For PC signals
- **Component** : For component signals
- **Composite** : For composite signals



PC Setting

Adjusts the settings for PC signals.

- The items below are unadjustable when no PC signal is input: "H Size", "V Size", "Dot Clock", "Clock Phase", "PC Position Adjustment", and "Auto Position Adjustment".
- "Auto Position Adjustment" is unavailable for INPUT-4.
- "Dot Clock" and "Clock Phase" are unavailable for INPUT-1, INPUT-2 and INPUT-3.

◆ Sampling Mode

Sets the display size for an analog input signal.

- **Std** : For VGA60 and XGA60 signals
- **Wide** : For WVGA60, WXGA (1280), WXGA (1360) and WXGA60 signals

◆ WXGA Select

Sets the display size for an analog input signal.

- **1280*768** : For WXGA (1280) signal
- **1360*768** : For WXGA (1360) signal
- **1366*768** : For WXGA60 signal

◆ SXGA / SXGA+

Sets the display size for an analog input signal.

- **SXGA** : For SXGA60 signal
- **SXGA+** : For SXGA+60 signal

◆ H Size

Adjusts the picture width.

- **-20 - +20** (Smaller ↔ Larger)

◆ V Size

Adjusts the picture height.

- **-20 - +20** (Smaller ↔ Larger)



◆ **Dot Clock**

Adjust this when the picture is not aligned vertically.

- The adjustment is kept after turning off the power.

■ **-20 – +20**

◆ **Clock Phase**

Adjust this when letters on the screen look blurred or swaying.

- The adjustment is kept after turning off the power.

■ **0 – 31**

◆ **PC Position Adjustment**

Adjusts the picture position on the monitor.

- The adjustment is kept after turning off the power.

◆ **Auto Position Adjustment**

Adjusts the picture position automatically.

◆ **Reset**

Restores the settings of “PC Setting” to the initial.

Reset

Restores the settings of “Setup” to the initial.

HDMI

Control with HDMI

Makes an HDMI CEC-compatible external component controllable through this monitor.

- **On** : Enables HDMI CEC control.
- **Off** : Deactivates HDMI CEC control.

One Touch Play

Starting playback on an HDMI CEC-compatible external component automatically turns on the monitor and change its source to the component.

- The setting is fixed to "Off" and unadjustable when "Control with HDMI" is set to "Off".
 - Dedicated HDMI components cooperate with the monitor regardless of the setting.
- **On / Off**

Power Off Link

Turning off the monitor automatically turns off an HDMI CEC-compatible external component.

- The setting is fixed to "Off" and unadjustable when "Control with HDMI" is set to "Off".
 - Dedicated HDMI components cooperate with the monitor regardless of the setting.
- **On / Off**

AMP Control

Makes an HDMI CEC-compatible amplifier controllable through the monitor.

- The setting is fixed to "Off" and unadjustable when "Control with HDMI" is set to "Off".

- **On / Off**

Input-1 Audio

Selects the audio signal type for INPUT-1.

- **Auto** : Detects the type automatically.
- **Digital** : For HDMI equipment.
- **Analogue** : For DVI equipment.

Reset

Restores the settings of "HDMI" to the initial.



Troubleshooting

The following are not malfunctions.

- This LCD display is built with very high precision technology; however, be aware that a few pixels may be missing or constantly lit.
- When a still image is displayed for a long time, it may remain indistinctly on the screen after the picture has changed. The remaining picture will disappear after a while.
- The following symptoms are problems only when pictures or sounds are not played back normally.
 - A slight electric shock occurs when you touch the monitor.
 - The top and/or rear panel of the monitor becomes hot.
 - The monitor emits a cracking noise.
 - The monitor emits a mechanical noise.
- If the monitor does not operate normally, perform the following to reset the monitor.
 - Turn off the power switch on the rear of the monitor, and turn it on again.
 - Unplug the monitor from the wall outlet, and plug it in again.

Cannot turn on the monitor.

- Connect the power cord properly. (→ page 10)
- Turn on the power switch. (→ page 10)

The remote control does not work.

- Insert the batteries in the correct direction. (→ page 05)
- Replace the batteries with new ones.
- Aim the remote control to the remote sensor on the monitor. (→ page 11)
 - The effective range of the remote control is about seven meters.
- Get closer to the monitor.
- Remove any obstruction between the remote control and the monitor.

No picture from a connected device.

- Select the correct input on the monitor.
- Connect the external device properly.
- Turn on the external device and start playback.

No sound.

- Check the speaker cord connection. (→ page 05)
- Press the MUTE button (⊘).
- Check the amplifier connection.
 - When “AMP” is selected under “Speaker”, the sound is output from the amplifier, and not from the speakers of the monitor. (→ page 13)

No picture from HDMI devices.

- Select the correct input on the monitor.
- Use a cable marked with the HDMI logo.
- Please use a High Speed HDMI™ Cable. High Speed HDMI™ Cables are tested to carry an HD signal up to 1080p and higher. (→ page 09)

No sound from HDMI devices.

- Set "Input-1 Audio" properly. (→ page 37)

Cannot control HDMI CEC devices.

- Set "Control with HDMI" to "On". (→ page 36)
- Some devices may not accept controls by HDMI CEC.

Cannot operate the product using the buttons on the monitor.

- Set "Front Panel Lock" to "Off". (→ page 29)

Picture from a computer is strange.

- Adjust the items under "PC Setting". (→ page 34)

The source indication stays on the display.

- Turn on the selected external device and start playback.
- When no signal is input, you cannot turn off the source indication.

The picture and the sound do not synchronize.

- Adjust "Lip Sync". (→ page 27)
- Adjust "Picture Delay Time". (→ page 25)

Colours are strange.

- Adjust the items under "Picture". (→ page A-2)
- Load one of the picture presets to discard the current settings and apply the selected preset. (→ page A-3)

Specifications

Model name	LT-42WX70EU
LCD panel	42-inch (viewable)
Screen size (visible area size measured diagonally)	107 cm
Display resolution	1920×1080
Display colours	16.77 million
Viewing angle (TYP.)	178 ° (Horizontally) 178 ° (Vertically)
Luminance (TYP.)	450 cd/m ²
Contrast ratio (TYP.)	4000 : 1
Horizontal/vertical frequency (computer signal)	Horizontal: 31.469 kHz – 75.000 kHz Vertical: 60 Hz ± 5 Hz
Compliant video signal formats	→ page 44
Audio output	Speakers: 10 W + 10 W (Impedance 8 Ω)
Operating environment	Operating temperature: 0 °C – 40 °C Operating humidity: 20 % – 80 % (non-condensing) (Slightly variable depending on ambient conditions for installation.)
Power requirements	AC 100 V – 240 V, 50 Hz/60 Hz
Power consumption	175 W
Power consumption (on standby)	AC 230 V: 0.7 W AC 100 V: 0.4 W

Dimensions	→ page 43
Mass	12.0 kg (without the speaker unit and the stand) 17.8 kg (including the stand) 19.0 kg (including the speaker unit and the stand)
Supplied accessories	Power cable ×1, Speaker unit ×1, Screws for the speaker unit ×2, remote control unit ×1, AAA batteries ×2
Input terminals	HDMI ×3 D-sub (15 pin) ×1 Audio input (3.5 mm stereo mini jack)
Output terminals	Speaker output
External control	RS-232C

- For easy understanding, pictures and illustrations are shown by being emphasized, omitted or composed, and may slightly be different from actual products.
- Design and specifications are subject to change without notice.
- HDMI, the HDMI Logo and High-Definition Multimedia Interface are trademarks or registered trademarks of HDMI Licensing LLC.
- All company names and product names mentioned herein are used for identification purposes only, and may be the trademarks or registered trademarks of their respective companies.

Notice on transportation

- This monitor is precision equipment and needs dedicated packing material for transportation. Never use any packing material supplied from sources other than JVC or JVC-authorized dealers.

Dimensions

unit: mm

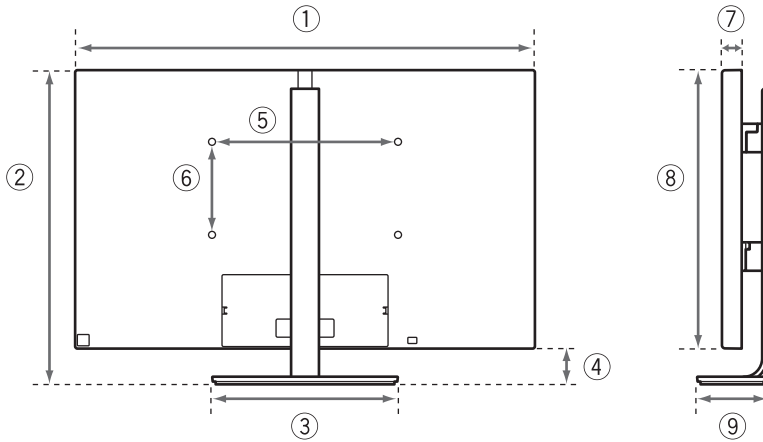

① : 990.0

② : 716.8^{*1} / 689.3^{*2} / 661.8^{*3}

③ : 400.0

④ : 117.0^{*1} / 89.5^{*2} / 62.0^{*3}

⑤ : 400.0

⑥ : 200.0

⑦ : 42.5

⑧ : 599.8

⑨ : 170.0

*1 At the high position

*2 At the middle position

*3 At the low position

Compliant signal formats (1)

INPUT-4 terminal (PC)

Signal	Frequency		
	Vertical (Hz)	Horizontal (Hz)	Dot clock (MHz)
PC98	56.42	24.823	21.050
VGA 60 ^{†1}	59.94	31.469	25.175
VGA 72	72.81	37.861	31.500
VGA 75	75.00	37.500	31.500
WVGA 60 ^{†2}	60.00	31.020	33.750
SVGA 60	60.32	37.879	40.000
SVGA 72	72.19	48.077	50.000
SVGA 75	75.00	46.875	49.500
XGA 60 ^{†1}	60.00	48.363	65.000
XGA 70	70.07	56.476	75.000
XGA 75	75.03	60.023	78.750
WXGA(1280) ^{†2†3}	59.87	47.776	79.500
WXGA(1360) ^{†2†4}	60.02	47.712	85.500
WXGA 60 ^{†2†5}	60.00	48.363	86.715
SXGA 60 ^{†6}	60.02	63.981	108.000
SXGA+ 60 ^{†7}	60.02	63.981	108.000
SXGA+ 60*	60.00	65.220	122.614
1280x720	60.00	45.000	74.250
1920x1080	60.00	67.500	148.500

†1 : Set "Sampling Mode" to "Std".

†2 : Set "Sampling Mode" to "Wide".

†3 : Set "WXGA Select" to "1280*768".

†4 : Set "WXGA Select" to "1360*768".

†5 : Set "WXGA Select" to "1366*768".

†6 : Set "SXGA / SXGA+" to "SXGA".

†7 : Set "SXGA / SXGA+" to "SXGA+".

	Total pixels		Effective pixels		Standard
	pixel per line	line per frame	pixel per line	line per frame	
	848	440	640	400	—
	800	525	640	480	VESA Standard
	832	520	640	480	VESA Standard
	840	500	640	480	VESA Standard
	1088	517	848	480	—
	1056	628	800	600	VESA Standard
	1040	666	800	600	VESA Standard
	1056	625	800	600	VESA Standard
	1344	806	1024	768	VESA Standard
	1328	806	1024	768	VESA Standard
	1312	800	1024	768	VESA Standard
	1664	798	1280	768	—
	1792	795	1360	768	VESA Standard
	1793	806	1366	768	—
	1688	1066	1280	1024	VESA Standard
	1688	1066	1400	1050	—
	1880	1087	1400	1050	—
	1650	750	1280	720	—
	2200	1125	1920	1080	—

- Signals in a format not listed above may not be displayed properly. Change the resolution setting on the PC.
- Some signals may not be displayed properly even if their format is in the list above.
- Because signals in PC98, VGA 72, VGA 75, SVGA 72, SVGA 75, XGA 70 and XGA 75 need to be converted into 60Hz before displayed on the monitor, playback of these signals look jerky. Select other signal formats for smoother playback of moving pictures.

Compliant signal formats (2)

INPUT-4 terminal (composite)

Signal	Frequency	
	Vertical (Hz)	Horizontal (Hz)
PAL/50	50.00	15.63
PAL/60	59.94	15.73
SECAM	50.00	15.63
NTSC3.58	59.94	15.73
NTSC4.43	59.94	15.73
PAL M	59.94	15.73
PAL N	50.00	15.63

INPUT-4 terminal (component)

Signal	Frequency	
	Vertical (Hz)	Horizontal (Hz)
480/60i	59.94	15.73
576/50i	50.00	15.63
480/60p	59.94	31.47
576/50p	50.00	31.25
720/60p	59.94	44.96
720/50p	50.00	37.50
1080/60i	59.94	33.72
1080/50i	50.00	28.13
1080/60p	59.94	67.43
1080/50p	50.00	56.25
1080/30p	29.97	33.72
1080/24p	24.00	27.00

INPUT-1, INPUT-2, INPUT-3 terminal (HDMI-HDMI)



Signal	Frequency		
	Vertical (Hz)	Horizontal (Hz)	Dot clock (MHz)
VGA 60	59.94/60	31.469/31.5	25.175/25.2
480/60p	59.94/60	31.469/31.5	27/27.027
720/60p	59.94/60	44.955/45	74.176/74.25
1080/60i	59.94/60	33.716/33.75	74.176/74.25
480/60i	59.94/60	15.734/17.75	27/27.027
1080/60p	59.94/60	67.433/67.5	148.352/148.5
576/50p	50.000	31.25	27
720/50p	50.000	37.5	74.25
1080/50i	50.000	28.13	74.25
576/50i	50.000	15.63	27
1080/50p	50.000	56.25	148.5
1080/24p	23.976/24	26.973/27	74.176/74.25
1080/25p	25.000	28.13	74.25
1080/30p	29.97/30	33.716/33.75	74.176/74.25

	Total pixels		Effective pixels	
	pixel per line	line per frame	pixel per line	line per frame
	800	525	640	480
	858	525	720	480
	1650	750	1280	720
	2200	562/563	1920	1080
	858	262/263	720	480
	2200	1125	1920	1080
	864	625	720	576
	1980	750	1280	720
	2640	562/563	1920	1080
	864	312/313	720	576
	2640	1125	1920	1080
	2750	1125	1920	1080
	2640	1125	1920	1080
	2200	1125	1920	1080

- Signals in a format not listed above may not be displayed properly. Change the resolution setting on the PC.
- Some signals may not be displayed properly even if their format is in the list above.

Index

Icons

-  12
-  12
-  12
-  12

Numbers

- 3DY/C 24
- 4:3 Aspect Setting 33
- 1080 Auto Setting 33

A

- AMP Control 37
- Auto Shut Off 29
- Auto Volume Control 27

B

- Backlight 18
- Backlight Setting 19
- Balance 27
- Bass 27
- Battery 05
- Brightness 17

C

- Colour 16
- Colour Management 22
- Colour Matrix 20
- Colour Mngmt. Setting 22
- Colour Space 20
- Colour System 19
- Colour Temperature 21
- Component 08

- Composite 08
- Computer 08, A-10
- Connection 08
- Contrast 17
- Contrast Setting 17
- Control with HDMI 36

D

- Digital camera A-11
- DVI 08

E

- Eco Mode 26
- Enhancer 18
- Enhancer Setting 18
- EXIT 14

F

- Front Panel Lock 29

G

- Gamma 23

H

- HDMI 36
- HDMI CEC 13
- Hue 16
- Hue Setting 16

I

- Information 32
- Input-1 Audio 37
- Input-4 Setting 33
- Input Label 33

- L**
- LINK 13
 - Lip Sync 27
- M**
- Main unit 11
 - MENU 14
 - Menu Language 29
- N**
- Natural Cinema 25
 - Noise Reduction 24
- O**
- One Touch Play 36
 - OPTION 12
 - Other 26
- P**
- PC Monitor Mode 25
 - PC Setting 34
 - PEQ 28
 - Picture A-2, 15
 - Picture Delay Time 25
 - Picture Management 23
 - Position Adjustment 32
 - Power cable 10
 - Power indicator 11
 - Power Indicator 32
 - Power Off Link 36
 - Power switch 10
- R**
- Remote control unit 12
 - Remote sensor 11
 - Reset 28, 35, 37
- S**
- Setup 29
 - Sharpness 18
 - Sound 27
 - Speaker unit 05
- T**
- Touch sensor panel 11
 - Treble 27
 - Turn On Volume 28
- V**
- Video game A-5
 - Volume Limit 28
- W**
- White Balance Setting 21
- Z**
- Zoom 30
 - ZOOM 12

JVC